



Prone Breast Treatment System

Caution: Federal Law restricts this device to sale by or on the order of a licensed Physician or Radiation Therapist.

DEVICE DESCRIPTION

Bionix Radiation Therapy Prone Breast Treatment System (PBRT-6025) is a reusable device intended to be used for the positioning and re-positioning of patients undergoing or receiving a course of external beam radiation therapy for the treatment of cancer and other diseases.

INDICATIONS

The Bionix Prone Breast Treatment System is intended to be used for the positioning and re-positioning of patients undergoing or receiving a course of external beam radiation therapy for the treatment of cancer and other diseases.

CONTRAINDICATIONS

No contraindications have been identified for the use of the Prone Breast Treatment System.

STORAGE

Store in a cool, dry environment.

ADVERSE REACTIONS

No adverse reactions have been identified for the use of the Prone Breast Treatment System.

WARNINGS

- Do NOT use if the package is damaged or open.
- Inspect the Prone Breast Treatment System before each use.
- Do NOT attempt to sterilize the Prone Breast Treatment System. Attempts to sterilize the Prone Breast Treatment System may result in product damage and / or patient injury.

CLEANING INSTRUCTIONS

Note: It is the user's responsibility to clean products according to hospital protocol / local regulations. Do not use alcohol-based cleaners on this product. Recommended cleaning procedures include:

1. Wipe thoroughly with water-based antiseptic cleaner or foam.
2. Allow to dry before next patient use.

Figure 1.

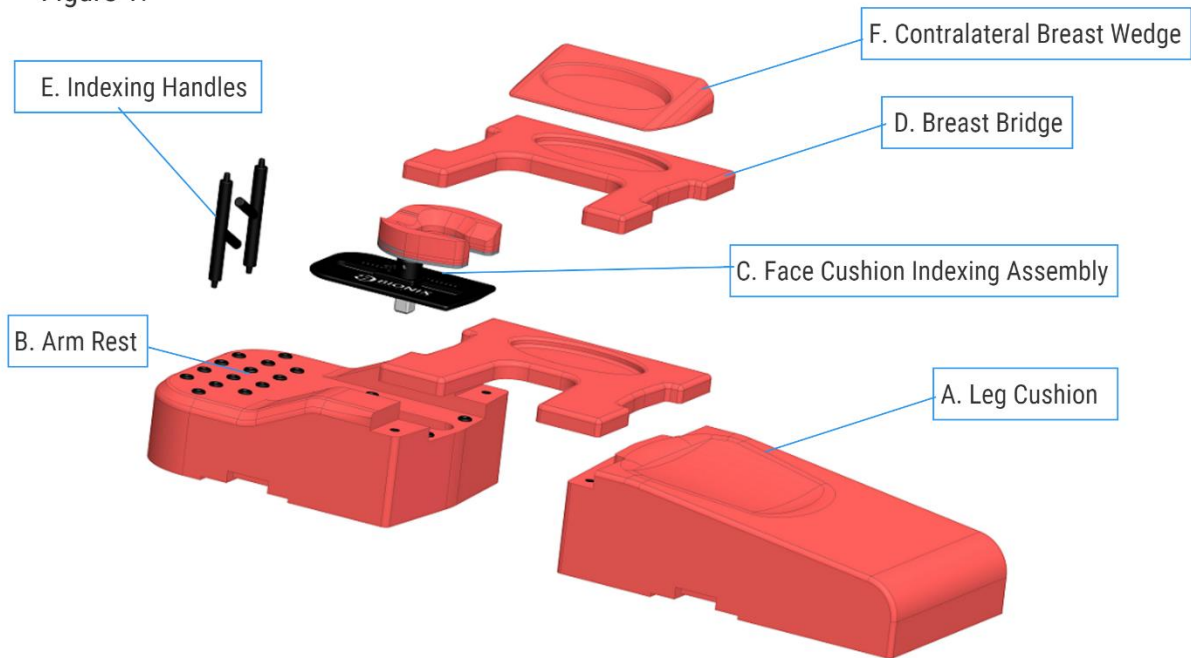

1. Assemble the Bionix Prone Breast Treatment System as shown in Figure 1. Place the Leg Cushion (A), and the Arm Rest (B) on the couch top and lock them down on the SecureFit bars. Bionix recommends using two SecureFit Bars (not included with the system).
 - a. Lockdown bars should be approximately 98cm apart, keeping the pad set superior to the couch top.
 - b. The Arm Rest (A) will attach on the SecureFit Bars at position A1 and B1 (not shown).
 - c. The Leg Rest (A) will attach on the SecureFit Bars at position A2 and B2 (not shown).
2. Place the Face Cushion Indexing Assembly (C) on the device. Loosen the knobs by turning counterclockwise and press the button to adjust the face cushion up and down. Secure by turning the knob clockwise and adjust to the patients' preference.
3. Place the Breast Bridge (D) by lifting and rotating 180 degrees (rotate clockwise or counterclockwise depending on which breast is being treated), as shown in Figure 2.
 - a. An optional 15 degree Contralateral Breast Wedge (F) can also be used for rotating the patient. Adjust the wedge to treatment needs and to the comfort of the patient. The optional ankle bolster (not shown in Figure 1, purchased separately) can be used to increase comfort level during treatment.

Figure 2.

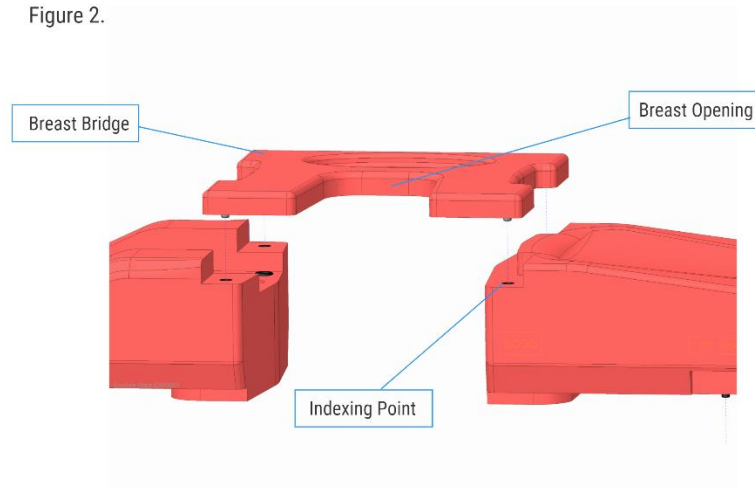

4. Have the patient engage the board from the bottom. The patient should lie flat in the prone position with the breast being treated, centered on the opening of the breast bridge. Line the breast in the opening as desired, according to individual treatment needs (See figure 2).
 - a. For the non-treated side, line up the patient with the indexing markings.
 - b. For the treated side, line up the patient with the tattoo marking.



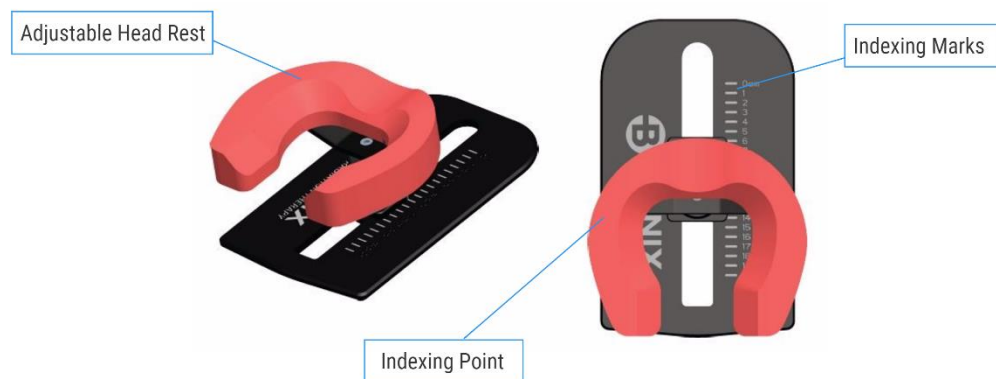















Figure 3.



5. Move the adjustable head rest to the appropriate position, favored by the patient (Figure 3). Be sure to note what position is being used on the patient positioning checklist. If indexing handles are used, be sure to note what position each hand is in. If desired, position the patient as such so that the hands are crossed and at maximum extension, to eliminate folding in the breast.

Visit www.BionixRT.com for Warranty information

Label Symbol Glossary (Note: not all symbols may be applicable to this product)

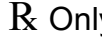
Symbol	Title of Symbol	Description of Symbol	Symbol Designation Number	Title of Symbol Standard Development Org. Standard
	Manufacturer	Indicates the medical device manufacturer, as defined in EU Directives 90/385/EEC, 93/42/EEC and 98/79/EC.	5.1.1	ISO 15223-2012
	Authorized representative in the European Community	Indicates the authorized representative in the European Community.	5.1.2	ISO 15223-2012
	Date of manufacture	Indicates the date when the medical device was manufactured.	5.1.3	ISO 15223-2012
	Use-By Date	Indicates the date after which the medical device is not to be used.	5.1.4	ISO 15223-2012
	Batch Code	Indicates the manufacturer's batch code so that the batch or lot can be identified.	5.1.5	ISO 15223-2012
	Catalog Number	Indicates the manufacturer's catalog number so that the medical device can be identified.	5.1.6	ISO 15223-2012
	Serial number	Indicates the manufacturer's serial number so that a specific medical device can be identified	5.1.7	ISO 15223-2012
	Sterilized using ethylene oxide	Indicates a medical device that has been sterilized using ethylene oxide.	5.2.3	ISO 15223-2012
	Sterilized using irradiation	Indicates a medical device that has been sterilized using irradiation.	5.2.4	ISO 15223-2012
	Do Not Resterilize	Indicates a medical device that is not to be resterilized.	5.2.6	ISO 15223-2012
	Non-sterile	Indicates a medical device that has not been subjected to a sterilization process.	5.2.7	ISO 15223-2012
	Do Not Use if Package is Damaged	Indicates a medical device that should not be used if the package has been damaged or opened.	5.2.8	ISO 15223-2012
	Biological Risks	Indicates that there are potential biological risks associated with the medical device.	5.4.1	ISO 15223-2012
	Do Not Reuse	Indicates a medical device that is intended for one use, or for use on a single patient during a single procedure.	5.4.2	ISO 15223-2012
	Consult Instructions For Use	Indicates the need for the user to consult the instructions for use.	5.4.3	ISO 15223-2012
	Caution	Indicates the need for the user to consult the instructions for use for important cautionary information such as warnings and precautions that cannot, for a variety of reasons, be presented on the medical device itself.	5.4.4	ISO 15223-2012
	European Conformity	EC Declaration of Conformity by Notified Body	Annex XII	MDD 93/42/EEC:2007
	European Conformity	European Conformity	Annex XII	MDD 93/42/EEC:2007
	By Prescription Only	Federal (USA) law restricts this device to sale, distribution, and use by or on the order of a physician.	N/A	FDA 81 Federal Register pg. 38911-38931

 Advena, Ltd.
Pure Offices, Plato Close
Warwick, CV34 6WE UK



Bionix Radiation Therapy, LLC.
5154 Enterprise Blvd.
Toledo, OH 43612
www.Bionixrt.com