



Omni V[®] SBRT Positioning System

Caution: Federal Law restricts this device to sale by or on the order of a licensed Physician or Radiation Therapist.

DEVICE DESCRIPTION

Bionix Radiation Therapy Omni V SBRT Positioning System (SBRT-4500) is a reusable device intended to be used for the positioning and re-positioning of patients undergoing or receiving a course of external beam radiation therapy for the treatment of cancer and other diseases.

INDICATIONS

The Bionix Omni V SBRT Positioning System is intended to be used for the positioning and re-positioning of patients undergoing or receiving a course of external beam radiation therapy for the treatment of cancer and other diseases.

CONTRAINDICATIONS

No contraindications have been identified for the use of the Omni V SBRT Positioning System.

STORAGE

Store in a cool, dry environment.

ADVERSE REACTIONS

No adverse reactions have been identified for the use of the Omni V SBRT Positioning System.

WARNINGS

- Do NOT use if the package is damaged or open.
- Inspect the Omni V SBRT Positioning System before each use.
- Do NOT attempt to sterilize the Omni V SBRT Positioning System. Attempts to sterilize the Omni V SBRT Positioning System may result in product damage and / or patient injury.

CLEANING INSTRUCTIONS

Note: It is the user's responsibility to clean products according to hospital protocol / local regulations. Do not use alcohol-based cleaners on this product. Recommended cleaning procedures include:

1. Wipe thoroughly with water-based antiseptic cleaner or foam.
2. Allow to dry before next patient use.

Figure 1.

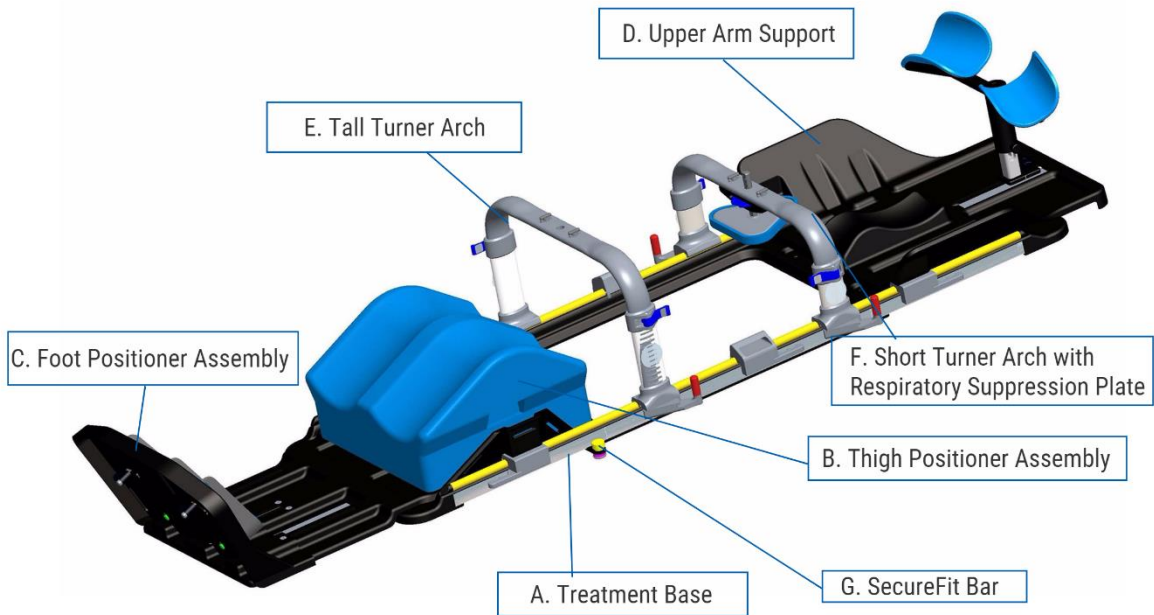

1. Place the Omni V SBRT Treatment Base (A) on the couch top with the appropriate SecureFit Bars (G) (Figure 1). Bionix Radiation Therapy suggests using two SecureFit Bars (G) (included with the system) with the treatment base.

Note: The engraved Bionix 'B' indicates the top of the treatment base.

Figure 2.

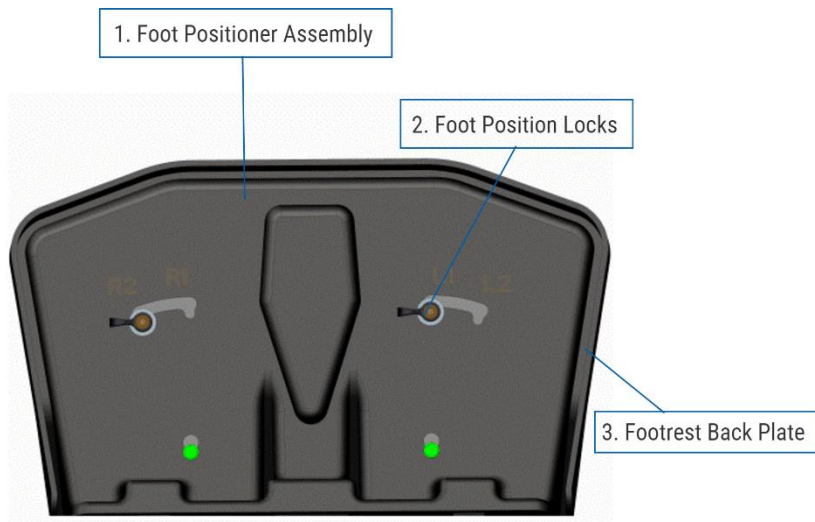
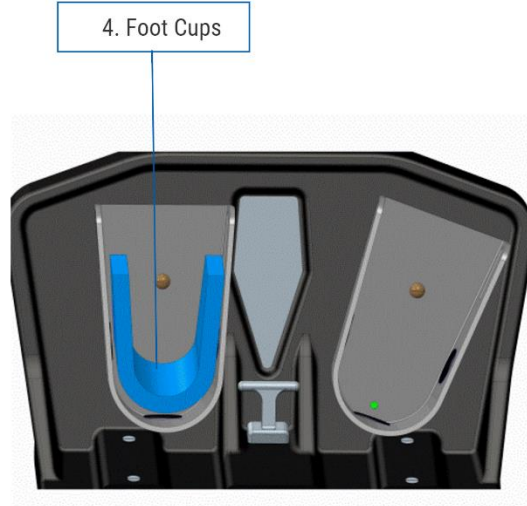

Figure 3.



Foot Positioner Assembly

2. Attach the Foot Positioner Assembly (1) onto the Treatment Base (A), Rotate the Foot Position Locks (2) so that the unlocked icon is visible. Secure in place by locking both sides.
3. Place the foot plate on the Treatment Base (A) in the approximate treatment position, as referred to on the patient positioning checklist.
4. Adjust, move and lock the Footrest Back Plate (3) according to the patient checklist. The Footrest Back Plate (3) can be moved forward or backward by pulling up on the lock pin. Pull up on the T-bar lock handle and position the foot plate until it matches up, according to the patient requirements on the patient positioning checklist. To adjust the angle of each individual footrest, lift up on the footrest and lock into the desired location.

Thigh Bolster

5. Place the Thigh Cushion on the Foot Positioner Assembly (1) with the Bionix Logo facing the bottom of the table. Use riser if desired.

Figure 4.

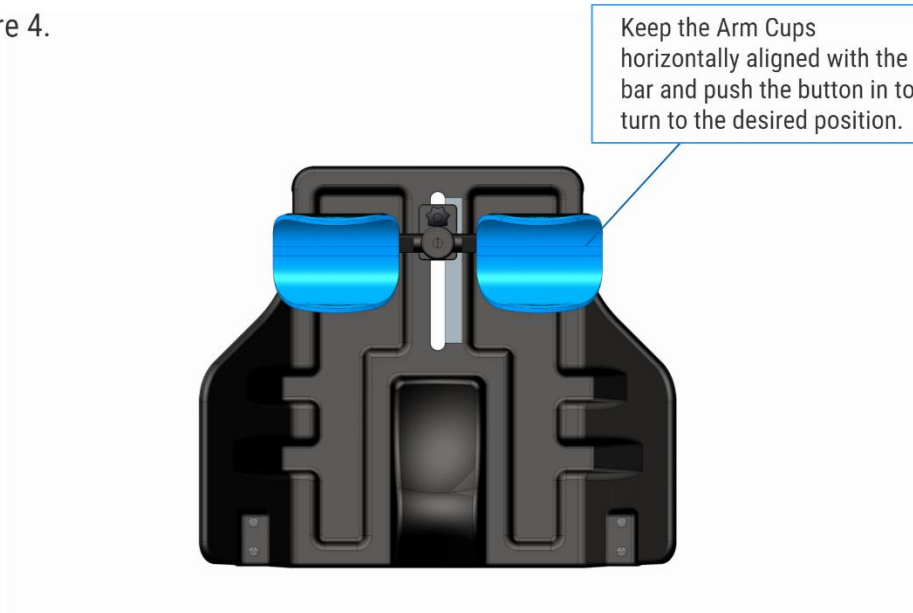
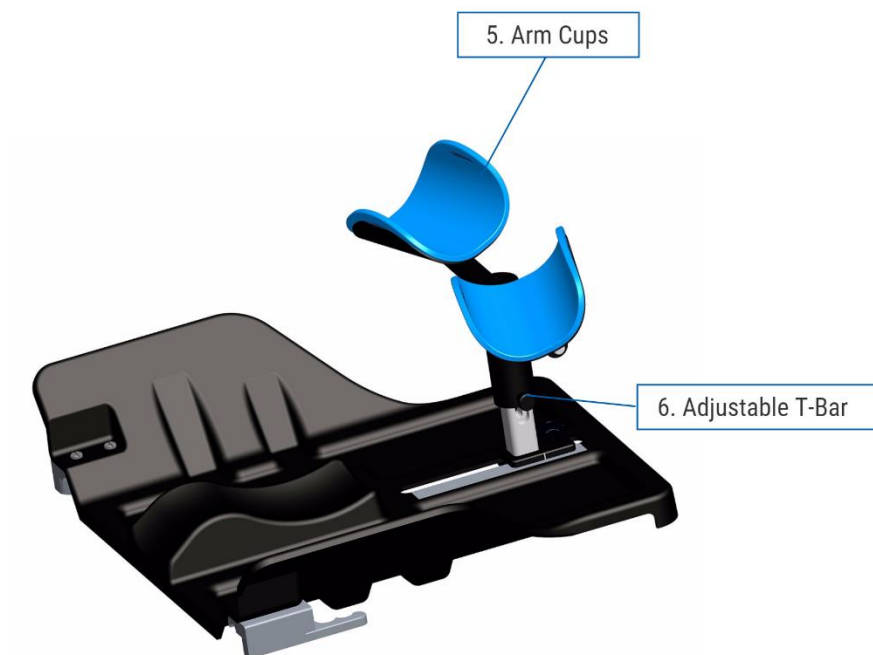

Figure 5.



Upper Arm Support

6. Place the Upper Arm Support Positioning on the Treatment Base (A) rails and place the Arm Cups onto the Adjustable T-Bar. Keep the Arm Cups horizontally aligned with the bar and push the button in to turn to the desired position. Adjust the T-Bar to desired height and distance. Lift the T-Bar handle by pushing the button in and moving the handle up and down.
7. The Arm Cups rotate (between 30 and 60 degrees) to comfortably fit the patient's forearms.

8. Place the desired Multi-Chambered SecureVac Cushion into the gap between the Thigh Cushion and the Upper Arm Support.
9. Position the patient into the system. Position the area being treated over the opening in the base and appropriately index the Footrest and Upper Arm Support positioning systems. Then, create a SecureVac Mold and record the patient's specific indexing points on the patient positioning checklist located at www.BionixRT.com.

Figure 6.

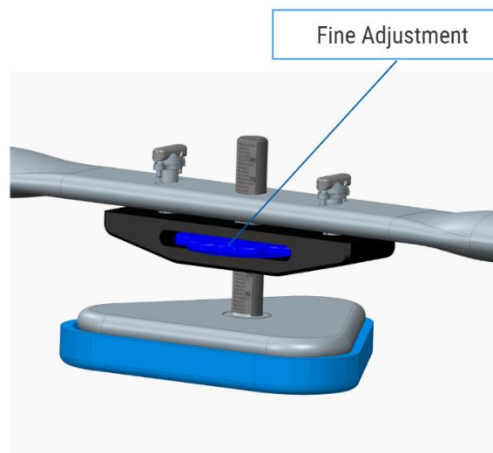

10. After the patient is positioned, select the preferred Turner Arch (E or F) and place onto the treatment base (A) railings. Initially, you will need to put the belt through the lock bases and secure into place by locking into position #2. Attach the compression plate by turning the locks 90 degrees (Figure 5). The arch should be placed over the area where the respiratory suppression is desired. Clamp in the unlocked position, which allows the arch to slide along the Treatment Base (A) railings. To lock the arch into place, push the lever so that it is parallel with the base. Release the arch by pulling the lever away from the base.

Figure 7.

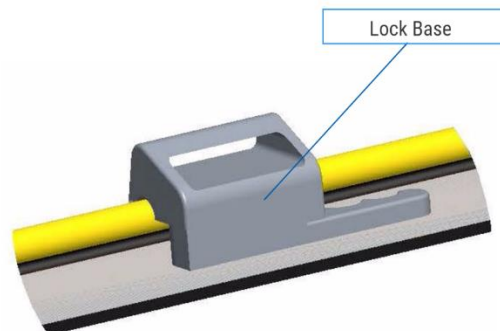





















11. To use the respiratory belt, loop it through the respiratory belt lock bases. Secure the loose end with the Velcro strap. Place the lock bases on the Treatment Base (A) rail and lock to the rail. Adjust belt straps so they are snug on the patient and record the indexing points on your patient positioning checklist (located at www.BionixRT.com). Attach the pump to the hose on the bladder and ensure the lock is unlocked and in the inflated position. Squeeze the aneroid gauge to inflate and record the level on the positioning sheet (located at www.BionixRT.com). To ensure that air does not leak through the monometer, clamp the tube with the white clamp. Place the monometer out of the treatment area.
12. Proceed with vacuuming the Multi-Chamber SecureVac Cushion. Please note that there are different multi-chambered SecureVac Cushion shapes and sizes.
13. Air can be inflated / evacuated by attaching the valve to a dual action pump (not included). Chambers are vacuumed independently from one another. Refine the Respiratory Plate (Figure 7) positioning as needed for the perfect fit on the desired restricted area.

Visit www.BionixRT.com for Warranty information

Label Symbol Glossary (Note: not all symbols may be applicable to this product)

Symbol	Title of Symbol	Description of Symbol	Symbol Designation Number	Title of Symbol Standard Development Org. Standard
	Manufacturer	Indicates the medical device manufacturer, as defined in EU Directives 90/385/EEC, 93/42/EEC and 98/79/EC.	5.1.1	ISO 15223-2012
	Authorized representative in the European Community	Indicates the authorized representative in the European Community.	5.1.2	ISO 15223-2012
	Date of manufacture	Indicates the date when the medical device was manufactured.	5.1.3	ISO 15223-2012
	Use-By Date	Indicates the date after which the medical device is not to be used.	5.1.4	ISO 15223-2012
	Batch Code	Indicates the manufacturer's batch code so that the batch or lot can be identified.	5.1.5	ISO 15223-2012
	Catalog Number	Indicates the manufacturer's catalog number so that the medical device can be identified.	5.1.6	ISO 15223-2012
	Serial number	Indicates the manufacturer's serial number so that a specific medical device can be identified	5.1.7	ISO 15223-2012
	Sterilized using ethylene oxide	Indicates a medical device that has been sterilized using ethylene oxide.	5.2.3	ISO 15223-2012
	Sterilized using irradiation	Indicates a medical device that has been sterilized using irradiation.	5.2.4	ISO 15223-2012
	Do Not Resterilize	Indicates a medical device that is not to be resterilized.	5.2.6	ISO 15223-2012
	Non-sterile	Indicates a medical device that has not been subjected to a sterilization process.	5.2.7	ISO 15223-2012
	Do Not Use if Package is Damaged	Indicates a medical device that should not be used if the package has been damaged or opened.	5.2.8	ISO 15223-2012
	Biological Risks	Indicates that there are potential biological risks associated with the medical device.	5.4.1	ISO 15223-2012
	Do Not Reuse	Indicates a medical device that is intended for one use, or for use on a single patient during a single procedure.	5.4.2	ISO 15223-2012
	Consult Instructions For Use	Indicates the need for the user to consult the instructions for use.	5.4.3	ISO 15223-2012
	Caution	Indicates the need for the user to consult the instructions for use for important cautionary information such as warnings and precautions that cannot, for a variety of reasons, be presented on the medical device itself.	5.4.4	ISO 15223-2012
	European Conformity	EC Declaration of Conformity by Notified Body	Annex XII	MDD 93/42/EEC:2007
	European Conformity	European Conformity	Annex XII	MDD 93/42/EEC:2007
	By Prescription Only	Federal (USA) law restricts this device to sale, distribution, and use by or on the order of a physician.	N/A	FDA 81 Federal Register pg. 38911-38931

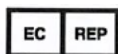

Advena, Ltd.
Pure Offices, Plato Close
Warwick, CV34 6WE UK



Bionix Radiation Therapy, LLC.
5154 Enterprise Blvd.
Toledo, OH 43612
www.Bionixrt.com